

ISTRUZIONI OPERATIVE OPERATING INSTRUCTIONS

SCAMBIATORI A PIASTRE PLATE HEAT EXCHANGERS

DECLARATION OF CONFORMITY

In comply with the Annex VII of the European Directive 2014/68/EU

We hereby declare that the pressure equipments detailed below have been designed, manufactured and tested in accordance with the European Directive 2014/68/EU:

Type: **Brazed Plate heat Exchanger**

Commercial Name: **S06-S07-S09
S22-S22H
S11-S12-S62-S71-S82-S87-S93
S16-S16H
S202
S222-S222H
S404-S424-S424H-S606**



Conformity assessment procedures followed: **MODULES B + C2**

Module B certificate No. **TIS-PED-MI-15-03-002622-8383**

Module C2 certificate No. **TIS-PED-MI-16-11-275908-10461**

Notified Body: **0948 TUV ITALIA SRL
TÜV SÜD Gruppe**

Responsible signature authorized established within the European Community :

ONDA S.p.A.

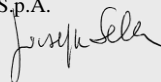

Manufacturer.

ONDA S.p.A. Via Vittoria, 158 36065 Mussolente (VI) ITALY



IS079 rev .12 del 21/11/2016

Advanced Heat transfer Solutions

DECLARATION OF CONFORMITY

In comply with the Annex VII of the European Directive 2014/68/EU

We hereby declare that the pressure equipments detailed below have been designed, manufactured and tested in accordance with the European Directive 2014/68/EU:

Type: **Brazed Plate heat Exchanger**

Commercial Name:



**S12H-S62H-S82H-S87H-S93H
S101-S182
S202H**

Conformity assessment procedures followed:

MODULES B + C2

Module B certificate No.

TIS-PED-MI-16-11-275908-10460

Module C2 certificate No.

TIS-PED-MI-16-11-275908-10461

Notified Body:

**0948 TUV ITALIA SRL
TÜV SÜD Gruppe**

Responsible signature authorized established within the European Community :

ONDA S.p.A.

Manufacturer.

Onda S.p.A. Via Vittoria, 158 36065 Mussolente (VI) ITALY



IS079 rev .12 del 21/11/2016

Advanced Heat transfer Solutions

MAXIMUM APPLICABLE CATEGORY BY MODEL

The Onda plate heat exchangers can be used to condense or evaporate coolants (gas/water exchangers) or used as single-phase heat exchangers (gas/gas).

The following charts report the PED category pertaining to each type of exchanger, calculated at maximum allowed pressure for each model.

	S06 PS=30 Bar		S06H PS=45 Bar	
	Fluid Gr-1	Fluid Gr-2	Fluid Gr-1	Fluid Gr-2
	Max n plates	Max n plates	Max n plates	Max n plates
Art.4.3	50	98	34	66
I	96	>98	66	>66
II	>98	-	>66	-
III	-	-	-	-
IV	-	-	-	-

	S07 PS=30 Bar		S07H PS=45 Bar	
	Fluid Gr-1	Fluid Gr-2	Fluid Gr-1	Fluid Gr-2
	Max n plates	Max n plates	Max n plates	Max n plates
Art.4.3	46	92	32	62
I	92	>92	62	>62
II	>92	-	>62	-
III	-	-	-	-
IV	-	-	-	-

	S09 PS=30 Bar		S09H PS=45 Bar	
	Fluid Gr-1	Fluid Gr-2	Fluid Gr-1	Fluid Gr-2
	Max n plates	Max n plates	Max n plates	Max n plates
Art.4.3	32	64	22	42
I	64	>64	42	>42
II	>64	-	>42	-
III	-	-	-	-
IV	-	-	-	-

	S22 PS=30 Bar		S22H PS=45 Bar	
	Fluid Gr-1	Fluid Gr-2	Fluid Gr-1	Fluid Gr-2
	Max n plates	Max n plates	Max n plates	Max n plates
Art.4.3	26	52	18	36
I	52	>52	36	>36
II	>52	-	>36	-
III	-	-	-	-
IV	-	-	-	-

	S82/S87/S93 PS=30 Bar		S82H/87H/93H PS=45 Bar	
	Fluid Gr-1	Fluid Gr-2	Fluid Gr-1	Fluid Gr-2
	Max n plates	Max n plates	Max n plates	Max n plates
Art.4.3	14	28	10	20
I	28	110	20	74
II	110	>110	74	>74
III	>110	-	>74	-
IV	-	-	-	-

	S182 PS=30 Bar		S182H PS=45 Bar	
	Fluid Gr-1	Fluid Gr-2	Fluid Gr-1	Fluid Gr-2
	Max n plates	Max n plates	Max n plates	Max n plates
Art.4.3	8	14	6	10
I	14	50	10	34
II	50	>50	34	166
III	>50	-	166	>166
IV	-	-	>166	-

	S202 PS=30 Bar		S202H PS=45 Bar	
	Fluid Gr-1	Fluid Gr-2	Fluid Gr-1	Fluid Gr-2
	Max n plates	Max n plates	Max n plates	Max n plates
Art.4.3	8	14	6	10
I	14	50	10	34
II	50	>50	34	166
III	>50	-	166	>166
IV	-	-	>166	-

	S404 PS=30 Bar			
	Fluid Gr-1	Fluid Gr-2		
	Max n plates	Max n plates		
Art.4.3	4	6		
I	6	24		
II	24	120		
III	120	>120		
IV	>120	-		

	S11/12 PS=30 Bar		S12H PS=45 Bar	
	Fluid Gr-1	Fluid Gr-2	Fluid Gr-1	Fluid Gr-2
	Max n plates	Max n plates	Max n plates	Max n plates
Art.4.3	24	48	16	32
I	48	>48	32	>32
II	>48	-	>32	-
III	-	-	-	-
IV	-	-	-	-

	S16 PS=30 Bar		S16H PS=45 Bar	
	Fluid Gr-1	Fluid Gr-2	Fluid Gr-1	Fluid Gr-2
	Max n plates	Max n plates	Max n plates	Max n plates
Art.4.3	22	42	14	28
I	42	>42	28	112
II	>42	-	112	>112
III	-	-	>112	-
IV	-	-	-	-

	S71 PS=30 Bar			
	Fluid Gr-1	Fluid Gr-2		
	Max n plates	Max n plates		
Art.4.3	14	28		
I	28	110		
II	110	>110		
III	>110	-		
IV	-	-		

	S606 PS=20 Bar			
	Fluid Gr-1	Fluid Gr-2		
	Max n plates	Max n plates		
Art.4.3	4	8		
I	8	26		
II	26	128		
III	128	>128		
IV	>128	-		

	S222 PS=30 Bar		S222H PS=45 Bar	
	Fluid Gr-1	Fluid Gr-2	Fluid Gr-1	Fluid Gr-2
	Max n plates	Max n plates	Max n plates	Max n plates
Art.4.3	14	26	10	18
I	26	100	18	66
II	100	>100	66	>66
III	>100	-	>66	-
IV	-	-	-	-

	S424 PS=30 Bar		S424H PS=45 Bar	
	Fluid Gr-1	Fluid Gr-2	Fluid Gr-1	Fluid Gr-2
	Max n plates	Max n plates	Max n plates	Max n plates
Art.4.3	6	12	6	10
I	12	54	10	38
II	54	274	38	182
III	274	-	182	>182
IV	-	-	>182	-

All the fluids of Group 1 and Group 2 are usable, **except R717 e R723.**

1. PRELIMINARY CAUTIONS

These Operator Instructions must be kept in good preservation conditions, in a place easily accessible to the appointed personnel. These Operator Instructions are not exempt from compliance with the laws in force regarding safety and on-the-job injury protection regulations. ONDA S.p.A. SHALL NOT BE LIABLE in the case of:

- ⇒ improper use of equipment under pressure;
- ⇒ alterations of the equipment under pressure;
- ⇒ non-compliance with safety regulations in force;
- ⇒ non-compliance with the content of these Operator Instructions.

2. INTRODUCTION

The plate exchangers are composed of a pile of corrugated plates, stacked onto each other between two closure plates. The pile of plates is subjected to a process of brazing with the forming of two separate circuits.

3. MATERIAL DELIVERY

Before carrying out any operation on the exchanger, check the correspondence between the ordered machine and the received one. Please also verify that the model of the exchanger has been adequately sized with the ONDA selection programme for the type of application.

3.1 Enclosed documents

These Operator Instructions are always enclosed with the exchanger.

4. HANDLING AND TRANSPORTATION

 LIFTING AND TRANSPORTATION MANEUVRES MUST BE PERFORMED BY QUALIFIED PERSONNEL

The plate exchanger includes attachments that protrude from the space occupied by the equipment under pressure. It is therefore recommended to handle with maximum care to prevent any impact or damage to the protruding parts.

Before handling the exchanger, it is necessary to verify the size and weight of the exchanger, written to allow the choice of an adequate lifting system.

A steel or synthetic fibre lashing must be used, with payload exceeding the weight of the load to be handled.

For exchangers of particular dimensions, please use the eyebolts specifically required for the exchanger:

- A eyebolts in horizontal position
- B eyebolts in vertical position, lifting from horizontal to vertical position

- C eyebolts in vertical position, lifting from vertical position

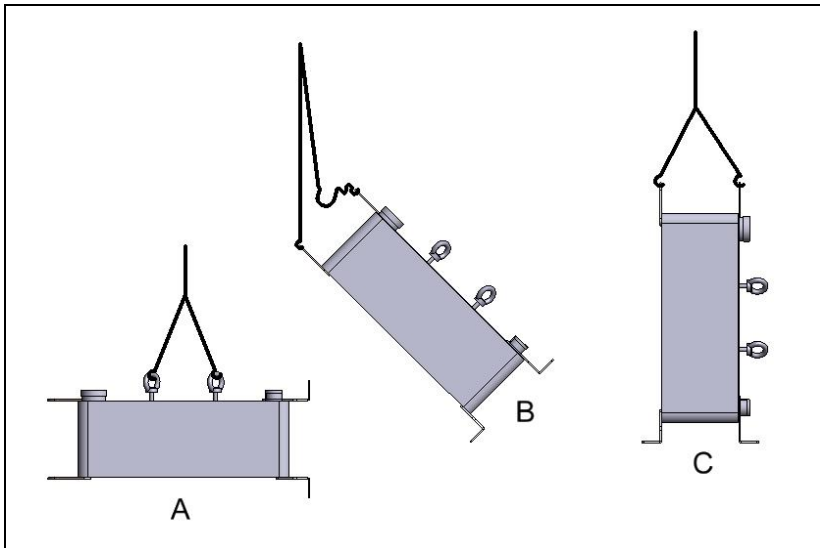

 **CAUTION: DO NOT HANDLE THE EXCHANGER WHEN IT IS UNDER PRESSURE**

5. INSTALLATION

5.1 CONNECTIONS:

In standard versions (one side with cooling circuit), the exchangers consist of 4 connections (F1, F2 e W1 W2) in the anterior part of the exchanger.

Additional connections can be present in the posterior part of the exchanger (BF1, BF2 e BW1 BW2)

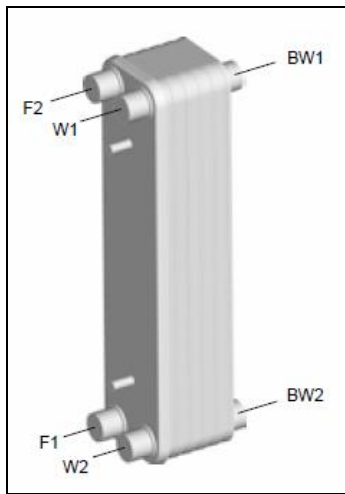

In the case of double-circuit plates (two circuits on cooling side), the connections of the 2 cooling circuits F1/F2 and G1/G2 are on the same side, while on the opposite side there is the circuit for the secondary fluid (W1 and W2). On the side with the cooling connections, there are additional connections BW1 and BW2 which can be used for temperature probes.

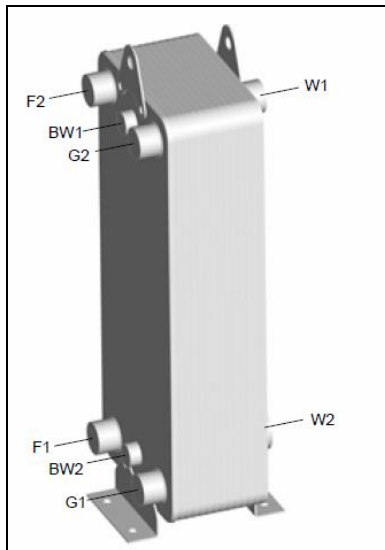

Depending on the type of application, the Onda plate connections may be of the following types: threaded internally (ISO-G), with flexible joint (Victaulic) or welded. The Onda standard plates of the gas-water type include attachments on the gas side of the welded type.

- For threaded attachment, avoid excessive tightening of the connections. Excessive force may ruin the brazing where the connection is placed.
- For welded connections:
 - Wrap a wet cloth at the base of the connection where the welding is done
 - Use alloys containing an amount of silver over 40%.

5.2 FILTERS:

Install a filter higher than the exchanger to prevent particles and suspended solid materials from entering the exchanger carried by the fluid. Clogging the canals may cause reduced performance, an increase in load leaks and an increase in the risk of freezing. Select the filter keeping in mind the minimum and maximum workload values of the exchanger.



Caution! Use a straining filter with passage holes not exceeding $900 \mu\text{m}$.

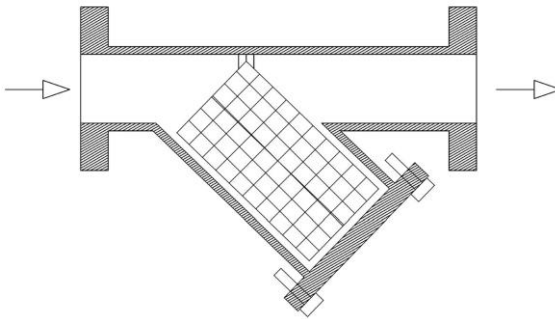

5.3 ASSEMBLY FOR WATER-WATER APPLICATION

For applications of the type water-water, in order to obtain optimal performance conditions, connect so that the flow of fluids is against the current, as shown in the illustration:

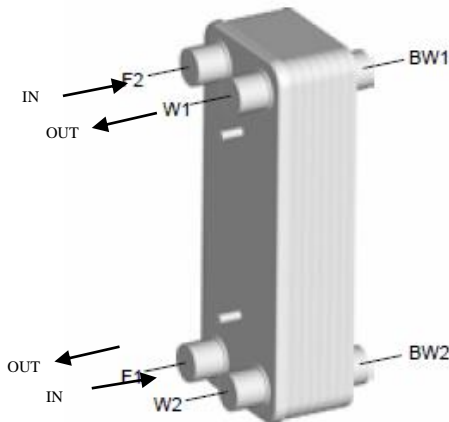

5.4 ASSEMBLY FOR APPLICATION WITH COOLANTS

For applications with coolants, install the exchanger in a vertical position.

For standard exchangers, the cooling circuit includes attachments at the left of the plate (F1 and F2). The water circuit attachments are positioned on the right (W1 and W2)

- **USE OF EVAPORATOR TYPE:**

Connect the cooling circuit and the water circuit as illustrated below: cooling entrance on the lower left side and water entrance on the upper right side.

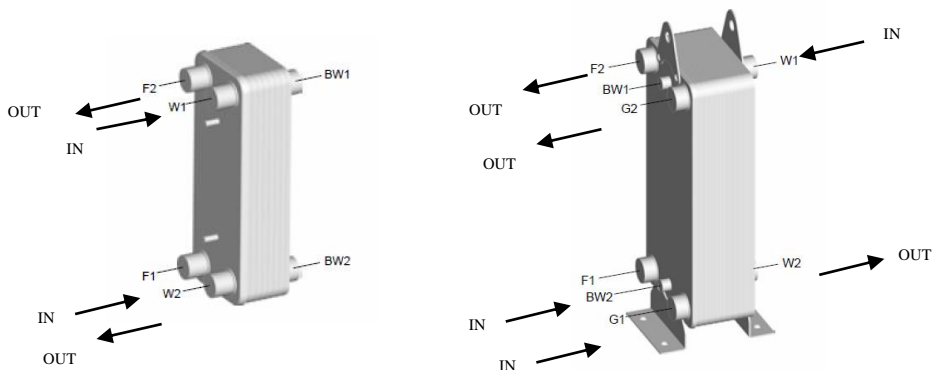

Expansion valve:

Place the expansion valve where the entrance attachment of the liquid coolant is. The valve must be of capacity slightly higher than that of the unit and the sensor located in the suction line should be isolated from the room temperature and sufficiently sensitive to quickly respond to variations in gas temperature. When choosing an expansion valve, please consider load leaks on the coolant side.

BRAZING-WELDING PROCEDURE

- Degrease and burnish the surfaces to be welded
- Insert the copper pipes into the connection, holding it in position and solder using a silver alloy of at least 45%.
- Do not direct the flame onto the exchanger.
- Use a wet cloth to prevent overheating of the exchanger.
- During welding of the exchanger, protect the interior of the circuit with a nitrogen flux to prevent oxidation.



CAUTION: excessive heating of the exchanger during brazing may cause the melting of the copper inside the plates and bring irreparable damage.

DAMP CLOTH

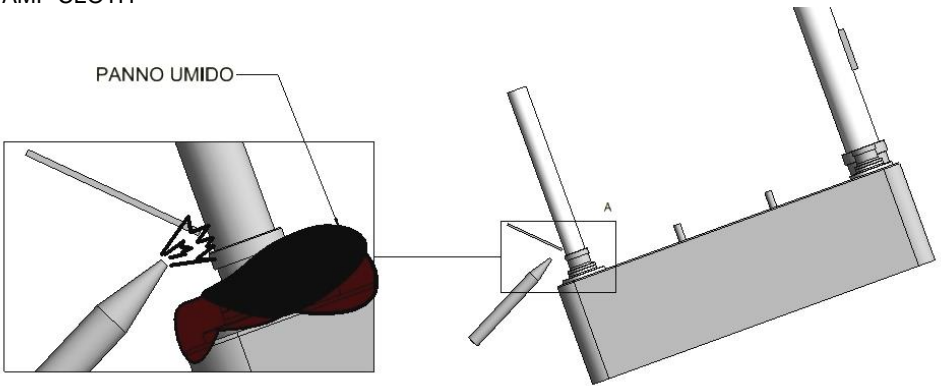

CORRECT INSTALLATION OF THE EXPANSION VALVE IN THE EXCHANGER

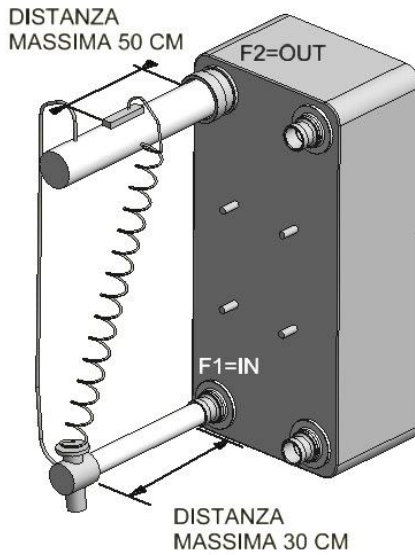



MAXIMUM DISTANCE 50 CM – MAXIMUM DISTANCE 30 CM

- USE OF CONDENSATOR TYPE:

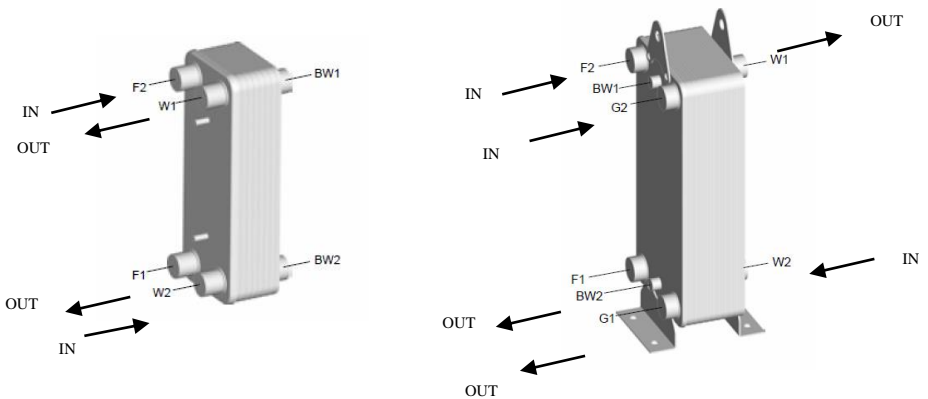
Connect the cooling circuit and water circuit as illustrated below: cooling entrance on the upper left side and water entrance on the lower right side for single-circuit exchangers. For double-circuit exchangers, the cooling entrance on the top and water entrance on the bottom, with exit on the opposite side.



For all uses:

-  Avoid using quick-closure valves to prevent sudden flow interruptions and water hammers
-  To prevent fatigue breakage of the exchanger, avoid excessive temperature and pressure fluctuations by using suitable adjustment systems.
-  Verify compatibility between the fluids and the construction materials of the exchanger.

5.5 Protection from vibration

Vibration coming from the system could damage the exchanger. Include flexible connections or dilation compensators to prevent vibrations, pulsations and strain from transmitting to the exchanger.

5.6 Isolation

Depending on the type of application, please isolate the exchanger.

6. USE



For correct functioning:







 ***DO NOT EXCEED THE MAXIMUM APPLICABLE LIMITS IN TERMS OF PRESSURE (PS) AND (TS) SHOWN ON THE DATA TAG***



 **Use anti-freezing solutions in the case in which the evaporation point is close to the freezing point of the liquid, after verifying its compatibility with the construction materials of the exchanger.**

FOR USE WITH COOLANTS

-  Use a thermostat with anti-freezing protection and a system for checking the flow to ensure constant water supply before, during and after the functioning of the compressor.

-  The exchanger must be equipped on the secondary fluid side with a temperature sensor so that the secondary fluid is at least 2K greater than its freezing point.
-  If the secondary fluid is absent, immediately switch off the compressor.
-  When the evaporation point of the fluid is lower than the freezing temperature of the secondary fluid, there is risk of freezing. If the coolant consists of a blend, there is risk of freezing, when the bubble point in the exchanger is lower than the freezing temperature of the secondary fluid.

-  If water is the secondary fluid, there is risk of freezing if the temperature is equal or less than 0°C (32°F).
-  Make sure the secondary fluid flows inside the exchanger before starting the compressor.
-  Make sure that the secondary fluid continues to flow inside the exchanger even after turning off the exchanger and while the pressure of the coolant is high enough to prevent freezing of the secondary fluid.
-  When the machinery is started, the temperature corresponding to the pressure of the coolant inside the exchanger must not be lower than the freezing point of the secondary fluid.
-  When the machinery is stopped, the temperature corresponding to the pressure of the coolant inside the exchanger must not be lower than the freezing point of the secondary fluid.
-  To prevent freezing phenomena with damage to the exchanger, do not pump-down the evaporator after turning it off: in other words, avoid using the compressor to achieve the set coolant pressure.
-  Do not expose the exchanger to strong, sudden variation in pressure.

-  During the shutdown phase of the exchanger, once the compressor has stopped, maintain the functioning of the pump for at least 5 minutes to prevent any freezing occurrence.
-  During the start-up phase, switch on the pump at least one minute before starting up the compressor to prevent any freezing occurrence.

7. MAINTENANCE AND USER CHECKS

 **DO NOT OPEN THE EXCHANGER WHEN IT IS UNDER PRESSURE.**

WATER CIRCUIT CLEANING:

In case of particularly hard water with a tendency to form deposits, it is possible to clean the exchanger through CIP (Cleaning In Place). There may be a decrease in performance due to the presence of deposits inside the exchanger. In such cases, force-wash using a suitable descaling chemical solution, after checking the compatibility with the construction materials of the exchanger.

Chemical washing must be carried out inside the water circuit; pump the chemical solution in the opposite direction to the one in the normal operation of the circuit.



For optimal cleaning, the flow of the descaling product should be at least 1.5 times greater than the normal flow used.



 Do not clean circuits working with cooling gas.

 Cleaning must be performed by specialised personnel.

 Always rinse the circuits with fresh water after chemical washing.

8. SAFETY

-  Always install safety accessories compliant to the national regulations of the country of use; a fire for external causes will provoke the exceeding of admissible limits for pressurised equipment.
-  Do not expose pressurised equipment to any impact during functioning.
-  Do not weld on the equipment body under pressure.

-  Do not use the pressurised equipment for uses that differ from what is prescribed.
-  In case of leak detection, immediately switch off the functioning exchanger.

9. DISPOSAL

This pressurised equipment contains recyclable materials: when the machinery stops functioning, please enquire on the current regulations in your country on the matter of recycling.

10. WARRANTY

- A.** ONDA S.p.A. guarantees the absence of faults and defects in the workmanship and in the materials of its Products for 18 months from the date of delivery.
Therefore, during the warranty period, where any defects in the Products are objectively valid and recognized in writing by ONDA SpA, the latter will provide free repair or, at its discretion, the replacement of defective Products, with delivery ex works (Ex Works - Incoterms 2000). The ONDA plant is at the address: via Lord Baden Powell, 11 - 36045 Lonigo (VI) – Italy.
- B.** Under penalty of loss of warranty, the Customer shall notify in writing, through registered letter with acknowledgment of receipt, of any defects or faults found within and not later than 10 (ten) days after the delivery of the Products at the Client's headquarters or other place indicated therein or, in the case of occult defects and/or defects, not later than 10 (ten) days after their discovery. In this case, the burden of proof of the date of discovery will be borne by the Customer.
- C.** ONDA S.p.A. also warrants that the Products are manufactured in accordance with the Italian laws and the European Community regulations in force at the date of confirmation by ONDA S.p.A. of the Customer order.
Unless otherwise agreed between the parties, all other expenses incurred by the replacement and/or repairing will be borne by the Customer and be at the Customer's risk.
- D.** The warranty is void if the faults or defects of the Products have been caused by the following:
- natural wear and tear;
 - unauthorized repairs or modifications;
 - improper use and application;
 - excessive thermal stress, even occasional;
 - excessive electrical or mechanical stress;
 - failure to comply with the functional and environmental parameters indicated by ONDA S.p.A. for the proper use and operation of the Products;
 - Installation of Products different from those indicated in the technical specifications provided by ONDA S.p.A.;
 - any other cause attributable to Customer's negligence.
- E.** The warranty is also void in case of:
- any non-compliance of the Products with applicable laws and/or regulations at the place where the Products are installed and/or assembled by the Customer and/or at the place of end use of the Products, if the Customer has not expressly requested the conformity of the Products to these laws and/or

regulations and has not regularly informed ONDA S.p.A. of their content before the sending date of the order confirmation of the latter.

- It is understood that this limitation is also effective with reference to specific regulations in force in EU countries and applicable autonomously to the European Community legislation.

F. In the event of any non-compliance of the Products with Italian and/or foreign laws and/or regulations coming into effect after the sending date of the order confirmation of ONDA S.p.A., the replacement of the Products or their possible adaptation to the new regulations shall be excluded.

However, Onda S.p.A shall not be liable for the use of Products in non-compliance with Italian and/or foreign laws and/or regulations that came into force after the sending date of the relevant order confirmation by ONDA S.p.A.

G. The Customer must not sell or market Products that do not comply with the laws and/or regulations mentioned in the previous letters E-F. Contrarily, the Customer shall relieve ONDA S.p.A. from any damages and/or losses suffered as a result of disputes filed by court or out-of-court means, by any third party or by public authority as a result of the manufacturing by ONDA S.p.A. of products not complying with the aforementioned laws and/or regulations.

H. Notwithstanding Presidential Decree 224/1988, on matter of liability for defective products, and the responsibility of ONDA S.p.A. in the event of gross negligence, in no event shall ONDA S.p.A. be liable for any direct, indirect or accidental damages arising in any way from the defect of the Products.

I. Appearance: copper accumulation due to the brazing process may occur on BPHE surfaces. This formation is not corrosion and does not affect the performance of the exchanger. For further information, please contact Onda S.p.A.

HIGHEST APPLICABLE CATEGORY OF THE PRESSURE EQUIPMENT

ONDA BPHE can be used to condensate or evaporate refrigerant fluids (refrigerant/ water BPHE) or as single-phase heat exchangers (refrigerant/refrigerant BPHE).

In the tables below, according to 97/23/EC, there is the highest applicable category for each model at the maximum allowable pressure.

	S06 PS=30 Bar		S06H PS=45 Bar	
	Fluid Gr-1	Fluid Gr-2	Fluid Gr-1	Fluid Gr-2
	Max n plates	Max n plates	Max n plates	Max n plates
Art.4.3	50	98	34	66
I	96	>98	66	>66
II	>98	-	>66	-
III	-	-	-	-
IV	-	-	-	-

	S07 PS=30 Bar		S07H PS=45 Bar	
	Fluid Gr-1	Fluid Gr-2	Fluid Gr-1	Fluid Gr-2
	Max n plates	Max n plates	Max n plates	Max n plates
Art.4.3	46	92	32	62
I	92	>92	62	>62
II	>92	-	>62	-
III	-	-	-	-
IV	-	-	-	-

	S09 PS=30 Bar		S09H PS=45 Bar	
	Fluid Gr-1	Fluid Gr-2	Fluid Gr-1	Fluid Gr-2
	Max n plates	Max n plates	Max n plates	Max n plates
Art.4.3	32	64	22	42
I	64	>64	42	>42
II	>64	-	>42	-
III	-	-	-	-
IV	-	-	-	-

	S22 PS=30 Bar		S22H PS=45 Bar	
	Fluid Gr-1	Fluid Gr-2	Fluid Gr-1	Fluid Gr-2
	Max n plates	Max n plates	Max n plates	Max n plates
Art.4.3	26	52	18	36
I	52	>52	36	>36
II	>52	-	>36	-
III	-	-	-	-
IV	-	-	-	-

	S11/12 PS=30 Bar		S12H PS=45 Bar	
	Fluid Gr-1	Fluid Gr-2	Fluid Gr-1	Fluid Gr-2
	Max n plates	Max n plates	Max n plates	Max n plates
Art.4.3	24	48	16	32
I	48	>48	32	>32
II	>48	-	>32	-
III	-	-	-	-
IV	-	-	-	-

	S16 PS=30 Bar		S16H PS=45 Bar	
	Fluid Gr-1	Fluid Gr-2	Fluid Gr-1	Fluid Gr-2
	Max n plates	Max n plates	Max n plates	Max n plates
Art.4.3	22	42	14	28
I	42	>42	28	112
II	>42	-	112	>112
III	-	-	>112	-
IV	-	-	-	-

	S71 PS=30 Bar			
	Fluid Gr-1	Fluid Gr-2		
	Max n plates	Max n plates		
Art.4.3	14	28		
I	28	110		
II	110	>110		
III	>110	-		
IV	-	-		

	S82/S87/S93 PS=30 Bar		S82H/87H/93H PS=45 Bar	
	Fluid Gr-1	Fluid Gr-2	Fluid Gr-1	Fluid Gr-2
	Max n plates	Max n plates	Max n plates	Max n plates
Art.4.3	14	28	10	20
I	28	110	20	74
II	110	>110	74	>74
III	>110	-	>74	-
IV	-	-	-	-

	S182 PS=30 Bar		S182H PS=45 Bar	
	Fluid Gr-1	Fluid Gr-2	Fluid Gr-1	Fluid Gr-2
	Max n plates	Max n plates	Max n plates	Max n plates
Art.4.3	8	14	6	10
I	14	50	10	34
II	50	>50	34	166
III	>50	-	166	>166
IV	-	-	>166	-

	S202 PS=30 Bar		S202H PS=45 Bar	
	Fluid Gr-1	Fluid Gr-2	Fluid Gr-1	Fluid Gr-2
	Max n plates	Max n plates	Max n plates	Max n plates
Art.4.3	8	14	6	10
I	14	50	10	34
II	50	>50	34	166
III	>50	-	166	>166
IV	-	-	>166	-

	S404 PS=30 Bar			
	Fluid Gr-1	Fluid Gr-2		
	Max n plates	Max n plates		
Art.4.3	4	6		
I	6	24		
II	24	120		
III	120	>120		
IV	>120	-		

	S606 PS=20 Bar			
	Fluid Gr-1	Fluid Gr-2		
	Max n plates	Max n plates		
Art.4.3	4	8		
I	8	26		
II	26	128		
III	128	>128		
IV	>128	-		

	S222 PS=30 Bar		S222H PS=45 Bar	
	Fluid Gr-1	Fluid Gr-2	Fluid Gr-1	Fluid Gr-2
	Max n plates	Max n plates	Max n plates	Max n plates
Art.4.3	14	26	10	18
I	26	100	18	66
II	100	>100	66	>66
III	>100	-	>66	-
IV	-	-	-	-

	S424 PS=30 Bar		S424H PS=45 Bar	
	Fluid Gr-1	Fluid Gr-2	Fluid Gr-1	Fluid Gr-2
	Max n plates	Max n plates	Max n plates	Max n plates
Art.4.3	6	12	6	10
I	12	54	10	38
II	54	274	38	182
III	274	-	182	>182
IV	-	-	>182	-

All the fluids of Group 1 and Group 2 are usable, **except R717 e R723.**